

U T O P I A 

revigres

A JOURNEY THROUGH SPACE AND TILE

U T O P I

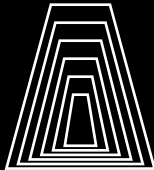
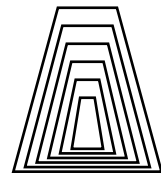

revigrés

A JOURNEY THROUGH SPACE AND TILE

Viaje até um espaço e tempo vindouros, em que todas as ideias e todos os projetos são passíveis de ser sonhados e concretizados com as novas soluções de cerâmica da Revigrés, resultado de uma atitude visionária e arrojada, sempre com foco no design, na inovação e na sustentabilidade.

Travel to a place and time to come, where all ideas and projects can be dreamt and fulfilled with Revigrés' new ceramic solutions, the result of a visionary and bold attitude, focusing on design, innovation and sustainability.

Voyagez jusqu'à un espace et un temps à venir, où toutes les idées et tous les projets peuvent être rêvés et réalisés avec les nouvelles solutions céramiques de Revigrés, résultat d'une attitude visionnaire et audacieuse, en mettant toujours en avant le design, l'innovation et la durabilité.

Viaje a un espacio y tiempo futuros, en el que se pueden soñar y materializar todas las ideas y proyectos con las soluciones cerámicas de Revigrés; resultado de una actitud visionaria y atrevida, siempre centrada en el diseño, en la innovación y la sostenibilidad.

MARBLES STATUARIO WHITE · CALACATTA CLASSIC 02

STONES LIMESTONE · TRAVERTINO CLASSIC 08 · 22

CONCRETE RULE · CITYZEN 12

TECH 20mm LAVASTONE · URBAN 18

METALLICS REFLEX 25

COLOURS BLOCK · BRICK 28

USEFUL INFORMATION 32

INFORMAÇÕES ÚTEIS · INFORMATIONS UTILES · INFORMACIÓN ÚTIL

GRANDES FORMATOS E ESPESSURADOS EM GRÉS PORCELÂNICO TÉCNICO

LIGHT XL - no formato 120x278cm - combina uma espessura reduzida (6mm) com uma elevada resistência técnica, introduzindo a elegância e funcionalidade que vão ao encontro das atuais tendências da arquitetura. A sua utilização permite criar um efeito visual de continuidade através da reprodução dos materiais naturais com a leveza que, por um lado, contribui para reduzir a pegada ecológica associada ao processo de produção e transporte e, por outro, torna a sua aplicação muito versátil.

Com diversos efeitos estéticos, o novo formato 120x120cm, adequado para pavimentos residenciais ou públicos, completa a gama da Revigrés, enquanto é também apresentada a nova espessura 20mm (nos formatos 60x60cm e 60x120cm), uma solução técnica com elevada resistência mecânica, ideal para aplicação em exteriores e em pisos técnicos sobreelevados.

NOVAS TEXTURAS E EFEITOS

Com a tecnologia TECH 3D de impressão digital de última geração, a Revigrés introduz superfícies inovadoras, em que a gráfica e texturas dos materiais cerâmicos convergem na perfeição, conferindo-lhes um efeito sensorial ultrarrealista inspirado na pedra natural travertino.

Por sua vez, o revivalismo do mosaico tradicional combinado com a versatilidade do grés porcelânico - nos formatos 14x14cm e 7x29cm - ou o mood urbano e contemporâneo do efeito metalizado, resultam em ambientes ecléticos e atuais que refletem a personalidade quem os projeta, em ambientes interiores ou exteriores.

Descubra este mundo onde o potencial criativo é ilimitado: uma UTOPIA.

GRANDS FORMATS ET ÉPAISSISSEMENTS EN GRÉS CÉRAME TECHNIQUE

LIGHT XL - au format 120x278cm - combine une épaisseur réduite (6mm) avec une résistance technique élevée, en introduisant une élégance et une fonctionnalité qui sont en phase avec les tendances architecturales actuelles. Son utilisation permet de créer un effet visuel de continuité grâce à la reproduction de matériaux naturels avec la légèreté qui, d'une part, contribue à réduire l'empreinte écologique associée au processus de production et de transport et, d'autre part, rend son application très polyvalente.

Avec différents effets esthétiques, le nouveau format 120x120cm, adapté aux sols résidentiels ou publics, complète la gamme Revigrés, alors que la nouvelle épaisseur de 20mm (dans les formats 60x60cm et 60x120cm) est également présentée, une solution technique à haute résistance mécanique, idéale pour la pose à l'extérieur et en plancher techniques surélevés.

NOUVELLES TEXTURES ET EFFETS

Avec la technologie TECH 3D d'impression numérique de dernière génération, Revigrés introduit des surfaces innovantes, où les graphismes et les textures des matériaux céramiques convergent à la perfection, en leur conférant un effet sensoriel ultraréaliste inspiré de la pierre naturelle travertin.

À son tour, le retour du carrelage traditionnel associé à la polyvalence du grés cérame - dans les formats 14x14 cm et 7x29 cm - ou le mood urbain et contemporain de l'effet métallisé, donnent lieu à des atmosphères éclectiques et contemporaines qui reflètent la personnalité de ceux qui les conçoivent, dans des environnements intérieurs ou extérieurs.

Découvrez ce monde où le potentiel créatif est illimité : une UTOPIE.

LARGE-FORMAT AND THICKENED TECHNICAL PORCELAIN TILES

LIGHT XL - 120x278cm - combines reduced thickness (6mm) with high technical strength, introducing elegance and functionality in tune with contemporary architecture trends. The tiles create a visual effect of continuity produced by mimicking natural materials with a lightness that, on the one hand, contributes to reducing the ecological footprint of manufacturing and transport, all the while ensuring versatile application.

With various aesthetic effects, the new 120x120cm format for residential or public-floor use completes the Revigrés range, while the new 20mm thick tiles (60x60cm and 60x120cm) provide a technical solution with high mechanical strength. Perfect for outdoor use and on raised floor.

NEW TEXTURES AND EFFECTS

Thanks to state-of-the-art TECH 3D digital printing technology, Revigrés introduces innovative tiles, where the graphics and textures of ceramic materials converge perfectly, conveying an ultra-realistic sensory effect inspired by natural travertine stone.

In turn, the revival of the traditional mosaic combined with the versatility of porcelain tiles - 14x14cm and 7x29cm - or the urban and contemporary mood of the metallic effect, result in eclectic and current environments that reflect the personality of the designers, in indoor or outdoor environments.

Discover this world where creative potential is unlimited: a UTOPIA.

GRANDES FORMATOS Y ESPEORES EN GRES PORCELÁNICO TÉCNICO

LIGHT XL - en el formato 120x278cm - combina un espesor reducido (6mm) con una alta resistencia técnica, ofreciendo la elegancia y la funcionalidad que van a la par de las actuales tendencias arquitectónicas. Con su utilización se logra un efecto visual de continuidad a través de la reproducción de materiales naturales con la ligereza que, por un lado, contribuye a reducir la huella ecológica asociada al proceso de producción y transporte y, por otro lado, hace que su aplicación sea muy versátil.

Con varios efectos estéticos, el nuevo formato 120x120cm, adecuado para pavimentos residenciales o públicos, completa la gama de Revigrés, al mismo tiempo que también se presenta el nuevo espesor de 20mm (en los formatos 60x60cm y 60x120cm), una solución técnica con gran resistencia mecánica, ideal para aplicar en exteriores y en suelos técnicos elevados.

NUEVAS TEXTURAS Y EFECTOS

Con la tecnología de impresión digital de última generación TECH 3D, Revigrés introduce superficies innovadoras, en las que los gráficos y las texturas de los materiales cerámicos convergen a la perfección, aportando un efecto sensorial ultrarrealista inspirado en la piedra natural travertino.

A su vez, el resurgimiento del mosaico tradicional combinado con la versatilidad del grés porcelánico - en los formatos 14x14cm y 7x29cm - o el estilo urbano y contemporáneo del efecto metalizado, ofrecen espacios ecléticos y modernos que reflejan la personalidad de quien los proyecta, en ambientes interiores o exteriores.

Descubra este mundo en el que el potencial creativo no tiene límite: una UTOPIA.



LIGHT XL

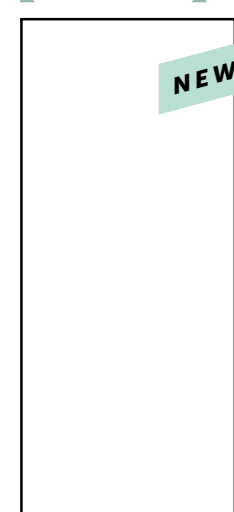

120x278 cm
± 0,60 cm

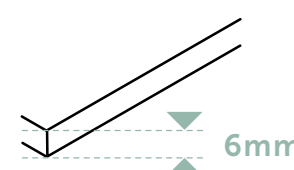

120x120 cm
± 0,90 cm

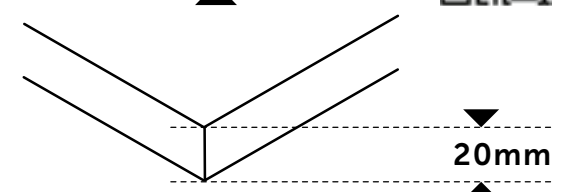

60x120 cm
60x60 cm
± 2,00 cm

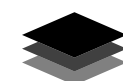

TECH 3D
IMPRESSÃO DIGITAL DE ÚLTIMA GERAÇÃO.
STATE-OF-THE-ART DIGITAL PRINTING TECHNOLOGY.
TECHNOLOGIE D'IMPRESION NUMÉRIQUE DE DERNIÈRE GÉNÉRATION.
TECNOLOGÍA DE IMPRESIÓN DIGITAL DE ÚLTIMA GENERACIÓN.



CALACATTA CLASSIC



STATUARIO WHITE · BRICK WHITE GLOSSY

STATUARIO WHITE

LIGHT XL

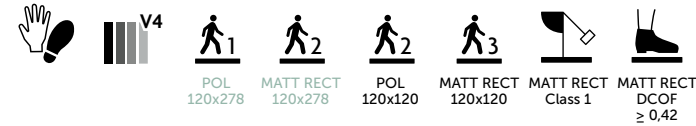
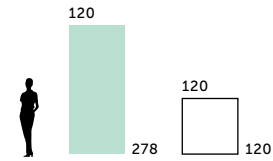

UP TO 3 DESIGNS
ATÉ 3 DESENHOS
JUSQU'À 3 DESSINS
HASTA 3 DISEÑOS



De modo a proteger a superfície das peças, os produtos no acabamento polido têm uma fina camada de impermeabilizante, que apenas deve ser removida após a conclusão da obra.
Tiles with polished finish are protected with waterproof coating that must be removed only after the works are concluded.

En vue de protéger la surface des pièces, les produits à la finition polie ont une fine couche d'imperméabilisant qui ne devrait être enlevée qu'après l'achèvement des travaux.

Con el fin de proteger la superficie de las piezas, los productos con acabado pulido tienen una fina capa de impermeabilizante, que solo debe eliminarse una vez terminado el trabajo.

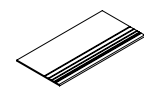

DG
29,5x119,8 cm **P97**
59,2x119,8 cm **P167**

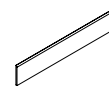

RB
8x119,8 **P28**

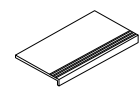

DG CF
29,5x59,2 cm **P157**

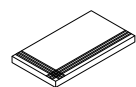

DG CF CANTO
29,5x59,2 cm **P207**

STATUARIO WHITE
119,8x277,8 cm
MATT RECT ± 0,60 cm **P149**
POL ± 0,60 cm **P173**

STATUARIO WHITE
119,8x119,8 cm
MATT RECT ± 0,90 cm **P127**
POL ± 0,90 cm **P140**

CALACATTA CLASSIC

LIGHT XL

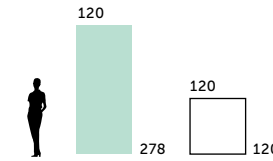

UP TO 4 DESIGNS
ATÉ 4 DESENHOS
JUSQU'À 4 DESSINS
HASTA 4 DISEÑOS



Tendo em vista alcançar um efeito global mais real e harmonioso, são produzidas peças diferentes umas das outras com variações de desenho e/ou cores entre elas.
For a more genuine and harmonious effect overall, different tiles with design and/or colour variations are produced.

Afin d'obtenir un effet global plus réel et harmonieux, nos pièces sont différentes les unes des autres avec des variations de dessin et / ou de nuances entre elles.

Para lograr un efecto global más real y armonioso, se producen piezas diferentes unas de otras con variaciones de diseño y/o color.

Para o assentamento de peças de grande formato, sugerimos a utilização de niveladores para ajudar a posicionar e nivelar peças.

When laying large format tiles, use levelling spacers to ensure proper installing and levelling of tiles.

Pour la pose de pièces de grand format, nous suggérons l'utilisation de croisillons autonivelants pour aider à positionner et à niveler les pièces.

Para la colocación de piezas de gran tamaño, sugerimos utilizar niveladores para ayudar a colocar y nivelar piezas.

LIGHT XL é ideal para renovações, sem demolições. Este grande formato de espessura fina garante a qualidade técnica do grés porcelânico aliada ao efeito estético apresentado.

LIGHT XL is perfect for renovation without demolition. This large, thin format guarantees the technical quality of porcelain tiles combined with the aesthetic effect described above.

LIGHT XL est idéal pour les rénovations, sans démolition. Ce grand format de faible épaisseur garantit la qualité technique du grés cérame combinée à l'effet esthétique présenté.

LIGHT XL es ideal para renovaciones, sin demoliciones. Este gran formato, con espesor fino, garantiza la calidad técnica del gres porcelánico aliado al efecto estético que presenta.

CALACATTA CLASSIC
119,8x277,8 cm
MATT RECT ± 0,60 cm **P149**
POL ± 0,60 cm **P173**

CALACATTA CLASSIC
119,8x119,8 cm
MATT RECT ± 0,90 cm **P127**
POL ± 0,90 cm **P140**



LIMESTONE SAND · CROMÁTICA LAGOON

LIMESTONE

LIGHT XL

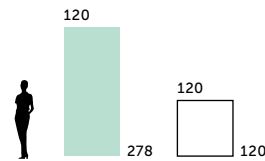

UP TO 4 DESIGNS
ATÉ 4 DESENHOS
JUSQU'À 4 DESSINS
HASTA 4 DISEÑOS



Antislip: Produtos que minimizam o risco de deslizamento.
Antislip: Products that minimize the risk of slipping.
Antislip: Produits qui réduisent le risque de glissement.
Antislip: Productos que minimizan el riesgo de deslizamiento.

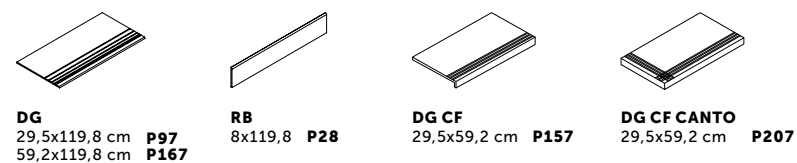

LIMESTONE MIST
119,8x277,8 cm
RECT ± 0,60 cm **P145**

LIMESTONE MIST
119,8x119,8 cm
RECT ± 0,90 cm **P120**
ANTISLIP RECT ± 0,90 cm **P120**

LIMESTONE

LIGHT XL

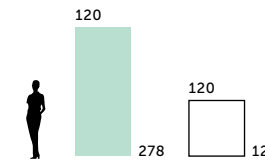

UP TO 4 DESIGNS
ATÉ 4 DESENHOS
JUSQU'À 4 DESSINS
HASTA 4 DISEÑOS

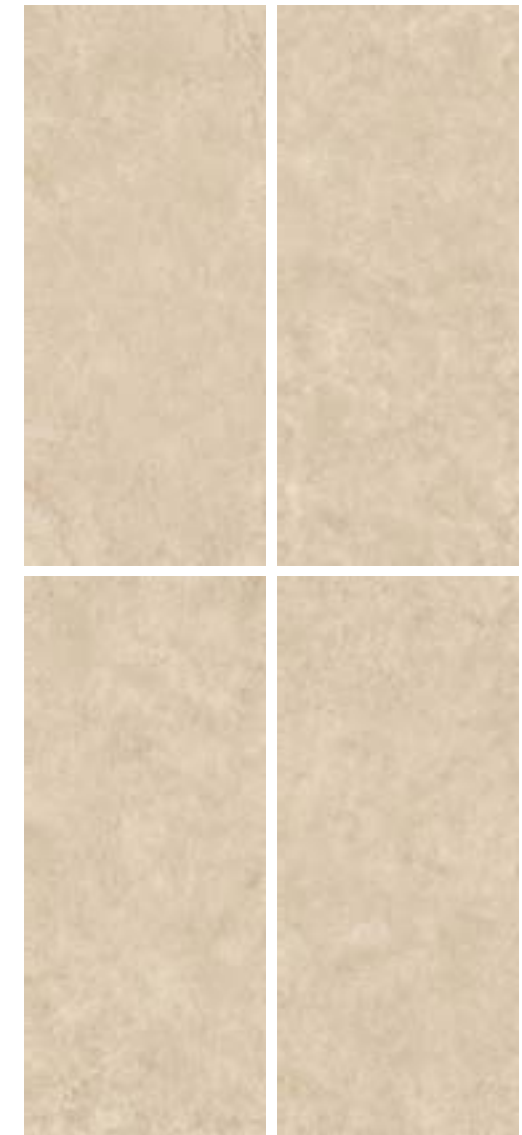
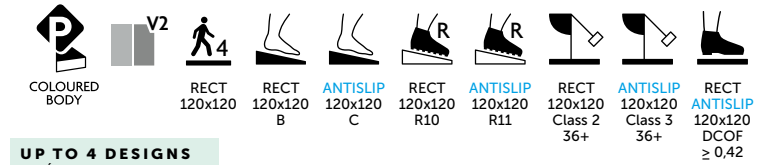

Tendo em vista alcançar um efeito global mais real e harmonioso, são produzidas peças diferentes umas das outras com variações de desenho e/ou cores entre elas.
For a more genuine and harmonious effect overall, different tiles with design and/or colour variations are produced.
Afin d'obtenir un effet global plus réel et harmonieux, nos pièces sont différentes les unes des autres avec des variations de dessin et / ou de nuances entre elles.
Para lograr un efecto global más real y armonioso, se producen piezas diferentes unas de otras con variaciones de diseño y/o color.

Para o assentamento de peças de grande formato, sugerimos a utilização de niveladores para ajudar a posicionar e nivelar peças.

When laying large format tiles, use levelling spacers to ensure proper installing and levelling of tiles.

Pour la pose de pièces de grand format, nous suggérons l'utilisation de croisillons autonivelants pour aider à positionner et à niveler les pièces.

Para la colocación de piezas de gran tamaño, sugerimos utilizar niveladores para ayudar a colocar y nivelar piezas.

LIGHT XL é ideal para renovações, sem demolições. Este grande formato de espessura fina garante a qualidade técnica do grés porcelânico aliada ao efeito estético apresentado.

LIGHT XL is perfect for renovation without demolition. This large, thin format guarantees the technical quality of porcelain tiles combined with the aesthetic effect described above.

LIGHT XL est idéal pour les rénovations, sans démolition. Ce grand format de faible épaisseur garantit la qualité technique du grés cérame combinée à l'effet esthétique présenté.

LIGHT XL es ideal para renovaciones, sin demoliciones. Este gran formato, con espesor fino, garantiza la calidad técnica del gres porcelánico aliado al efecto estético que presenta.

LIMESTONE SAND
119,8x277,8 cm
RECT ± 0,60 cm **P145**

LIMESTONE SAND
119,8x119,8 cm
RECT ± 0,90 cm **P120**
ANTISLIP RECT ± 0,90 cm **P120**



RULE SMOG · RULE ALLOY

UTOPIA

revigres

RULE

LIGHT XL

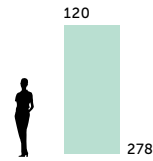

UP TO 3 DESIGNS
ATÉ 3 DESENHOS
JUSQU'À 3 DESSINS
HASTA 3 DISEÑOS



RULE ALLOY
119,8x277,8 cm
RECT ± 0,60 cm P145

RULE



LIGHT XL

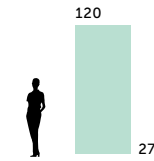

UP TO 3 DESIGNS
ATÉ 3 DESENHOS
JUSQU'À 3 DESSINS
HASTA 3 DISEÑOS



RULE SMOG
119,8x277,8 cm
RECT ± 0,60 cm P145

Tendo em vista alcançar um efeito global mais real e harmonioso, são produzidas peças diferentes umas das outras com variações de desenho e/ou cores entre elas.
For a more genuine and harmonious effect overall, different tiles with design and/or colour variations are produced.

Afin d'obtenir un effet global plus réel et harmonieux, nos pièces sont différentes les unes des autres avec des variations de dessin et / ou de nuances entre elles.

Para lograr un efecto global más real y armonioso, se producen piezas diferentes unas de otras con variaciones de diseño y/o color.

Para o assentamento de peças de grande formato, sugerimos a utilização de niveladores para ajudar a posicionar e nivelar peças.

When laying large format tiles, use levelling spacers to ensure proper installing and levelling of tiles.

Pour la pose de pièces de grand format, nous suggérons l'utilisation de croisillons autonivelants pour aider à positionner et à niveler les pièces.

Para la colocación de piezas de gran tamaño, sugerimos utilizar niveladores para ayudar a colocar y nivelar piezas.

LIGHT XL é ideal para renovações, sem demolições. Este grande formato de espessura fina garante a qualidade técnica do grés porcelânico aliada ao efeito estético apresentado.

LIGHT XL is perfect for renovation without demolition. This large, thin format guarantees the technical quality of porcelain tiles combined with the aesthetic effect described above.

LIGHT XL est idéal pour les rénovations, sans démolition. Ce grand format de faible épaisseur garantit la qualité technique du grés cérame combinée à l'effet esthétique présenté.

LIGHT XL es ideal para renovaciones, sin demoliciones. Este gran formato, con espesor fino, garantiza la calidad técnica del gres porcelánico aliado al efecto estético que presenta.



CITYZEN GRIS · REFLEX CORTEN

CITYZEN

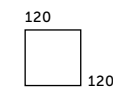

CITYZEN FOG
119,8x119,8 cm
MATT RECT ± 0,90 cm **P120**
ANTISLIP RECT ± 0,90 cm **P120**

CITYZEN BONE
119,8x119,8 cm
MATT RECT ± 0,90 cm **P120**
ANTISLIP RECT ± 0,90 cm **P120**



UP TO 8 DESIGNS
ATÉ 8 DESENHOS
JUSQU'À 8 DESSINS
HASTA 8 DISEÑOS

Antislip: Produtos que minimizam o risco de deslizamento.
Antislip: Products that minimize the risk of slipping.
Antislip: Produits qui réduisent le risque de glissement.
Antislip: Productos que minimizan el riesgo de deslizamiento.

Tendo em vista alcançar um efeito global mais real e harmonioso, são produzidas peças diferentes umas das outras com variações de desenho e/ou cores entre elas.
For a more genuine and harmonious effect overall, different tiles with design and/or colour variations are produced.

Afin d'obtenir un effet global plus réel et harmonieux, nos pièces sont différentes les unes des autres avec des variations de dessin et / ou de nuances entre elles.

Para lograr un efecto global más real y armonioso, se producen piezas diferentes unas de otras con variaciones de diseño y/o color.

Para o assentamento de peças de grande formato, sugerimos a utilização de niveladores para ajudar a posicionar e nivelar peças.

When laying large format tiles, use levelling spacers to ensure proper installing and leveling of tiles.

Pour la pose de pièces de grand format, nous suggérons l'utilisation de croisillons autonivelants pour aider à positionner et à niveler les pièces.

Para la colocación de piezas de gran tamaño, sugerimos utilizar niveladores para ayudar a colocar y nivelar piezas.

CITYZEN GRIS
119,8x119,8 cm
MATT RECT ± 0,90 cm **P120**
ANTISLIP RECT ± 0,90 cm **P120**

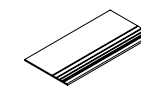

DG
29,5x119,8 cm **p97**
59,2x119,8 cm **P167**

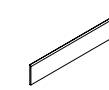

RB
8x119,8 **P28**

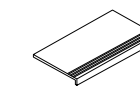

DG CF
29,5x59,2 cm **P157**

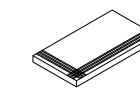

DG CF CANTO
29,5x59,2 cm **P207**



LAVASTONE PLATINA 20 mm · RULE ALLOY



ANTISLIP URBAN BONE 20 mm

LAVASTONE TECH 20 mm

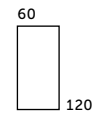
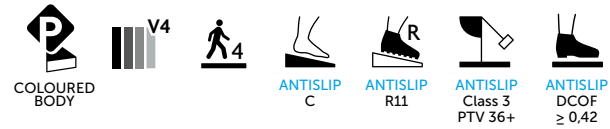

UP TO 7 DESIGNS
ATÉ 7 DESENHOS
JUSQU'À 7 DESSINS
HASTA 7 DISEÑOS

LAVASTONE PLATINA
59,8x119,8 cm
ANTISLIP RECT ± 2,0 cm P130

LAVASTONE FOG
59,8x119,8 cm
ANTISLIP RECT ± 2,0 cm P130

Antislip: Produtos que minimizam o risco de deslizamento.
Antislip: Products that minimize the risk of slipping.
Antislip: Produits qui réduisent le risque de glissement.
Antislip: Productos que minimizan el riesgo de deslizamiento.

Tendo em vista alcançar um efeito global mais real e harmonioso, são produzidas peças diferentes umas das outras com variações de desenho e/ou cores entre elas.
For a more genuine and harmonious effect overall, different tiles with design and/or colour variations are produced.
Afin d'obtenir un effet global plus réel et harmonieux, nos pièces sont différentes les unes des autres avec des variations de dessin et / ou de nuances entre elles.
Para lograr un efecto global más real y armonioso, se producen piezas diferentes unas de otras con variaciones de diseño y/o color.

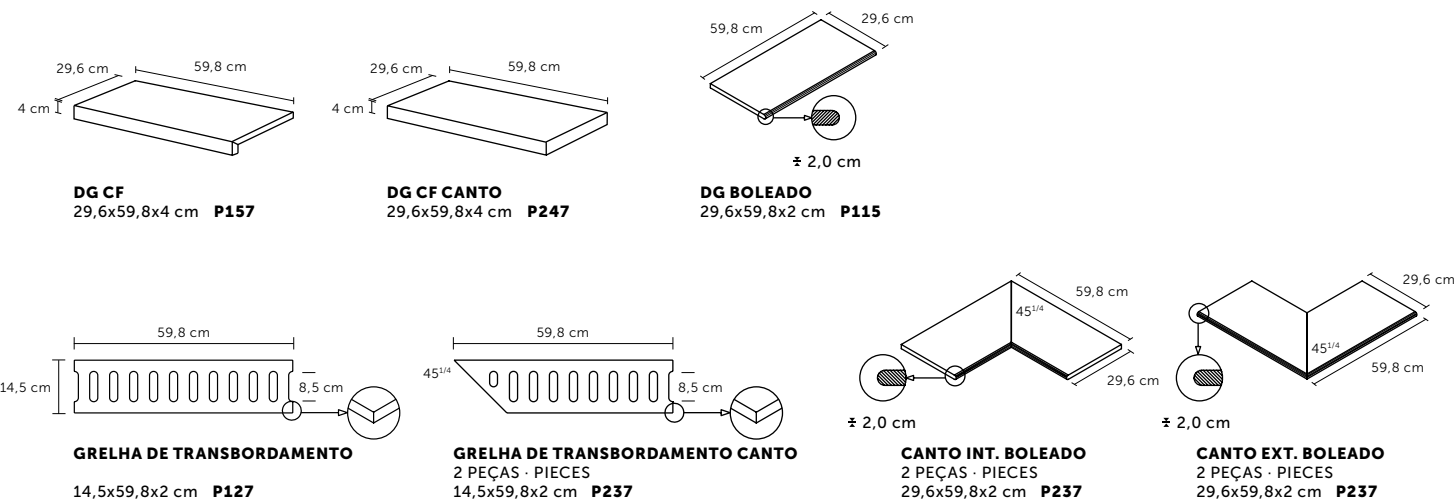

URBAN TECH 20 mm

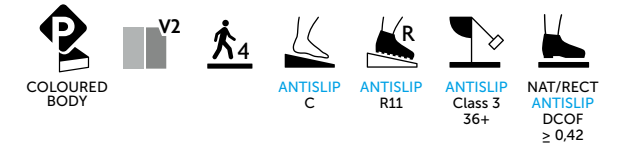

ANTISLIP URBAN FOG
59,8x59,8 cm
RECT ± 2,0 cm P103

ANTISLIP URBAN BONE
59,8x59,8 cm
RECT ± 2,0 cm P103



ANTISLIP URBAN GRIS
59,8x59,8 cm
RECT ± 2,0 cm P103

UP TO 12 DESIGNS
ATÉ 12 DESENHOS
JUSQU'À 12 DESSINS
HASTA 12 DISEÑOS

O TECH 20 mm é ideal para jardins, parques, terraços e espaços privados ou públicos de alto tráfego. Através da aplicação a seco, pode ser colocado sobre gravilha, relva, superfícies irregulares e pavimentos técnicos sobreelevados. De fácil e rápida aplicação, é ainda removível.
Com cimento cola, representa um produto de altíssima resistência mecânica, sendo adequado para garagens, espaços comerciais ou industriais. A solução ideal para combinar pavimento interior e exterior, com as coleções Lavastone e Urban.

Tech 20 mm is perfect for gardens, parks, terraces and private or heavy-duty public spaces. Through dry application, it can be laid on gravel, grass, uneven surfaces and raised floor. Easy and quick to install, and easily removable.
Laid with adhesive cement the tiles acquire very high mechanical strength; perfect for garages, commercial or industrial spaces. The ideal solution for combining indoor and outdoor flooring, with Lavastone and Urban collections.

TECH 20 mm est idéal pour les jardins, les parcs, les terrasses et les espaces privés ou publics à fort trafic. Grâce à la pose à sec, il peut être posé sur du gravier, du gazon, des surfaces irrégulières et des planchers techniques surélevés. Facile et rapide à poser, il est également amovible.
Avec le ciment-colle, il représente un produit de très haute résistance mécanique, approprié pour les garages, les espaces commerciaux ou industriels. La solution idéale pour combiner les sols intérieurs et extérieurs, avec les Lavastone et Urban collections.

Nova sobre espessurado TECH 20 mm es ideal para jardines, parques, terrazas y espacios privados o públicos con mucho tráfico. Si se aplica en seco, se puede colocar sobre gravilla, hierba, superficies irregulares y pavimentos técnicos elevados. Ofrece una aplicación fácil y rápida, además de ser removible.
Si se aplica con cemento cola, es un producto con una altísima resistencia mecánica, lo que lo hace adecuado para garajes, espacios comerciales o industriales. La solución ideal para combinar pavimento interior y exterior, con colecciones Lavastone y Urban.





TRAVERTINO SAND

TRAVERTINO CLASSIC

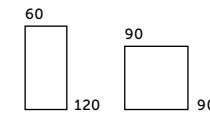
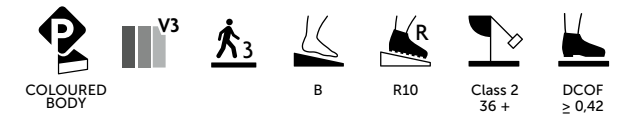

UP TO 16 DESIGNS
ATÉ 16 DESENHOS
JUSQU'À 16 DESSINS
HASTA 16 DISEÑOS



TRAVERTINO CLASSIC OFFWHITE
59,2x118,6 cm
MATT RECT ± 0,98 cm **P109**

88,9x88,9 cm
MATT RECT ± 1,05 cm **P109**

TRAVERTINO CLASSIC SAND
59,2x118,6 cm
MATT RECT ± 0,98 cm **P109**

88,9x88,9 cm
MATT RECT ± 1,05 cm **P109**

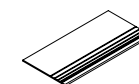

DG
29,5x59,2 cm **P18**
44,35x88,9 cm **P96**
29,5x118,6 cm **P96**

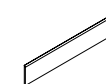

RB
8x59,2 cm **P12**
8x88,9 cm **P28**
8x118,6 cm **P28**

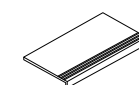

DG CF
29,5x59,2 cm **P157**

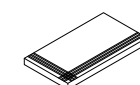

DG CF CANTO
29,5x59,2 cm **P207**

Tendo em vista alcançar um efeito global mais real e harmonioso, são produzidas peças diferentes umas das outras com variações de desenho e/ou cores entre elas.

For a more genuine and harmonious effect overall, different tiles with design and/or colour variations are produced.

Afin d'obtenir un effet global plus réel et harmonieux, nos pièces sont différentes les unes des autres avec des variations de dessin et/ou de nuances entre elles.

Para lograr un efecto global más real y armonioso, se producen piezas diferentes unas de otras con variaciones de diseño y/o color.

Com a tecnologia TECH 3D de impressão digital de última geração, a Revigrés introduz superfícies inovadoras, em que a gráfica e texturas dos materiais cerâmicos convergem na perfeição, conferindo-lhes um efeito sensorial ultrarrealista.

Thanks to state-of-the-art TECH 3D digital printing technology, Revigrés introduces innovative tiles, where the graphics and textures of ceramic materials converge perfectly, conveying an ultra-realistic sensory.

Avec la technologie TECH 3D d'impression numérique de dernière génération, Revigrés introduit des surfaces innovantes, où les graphismes et les textures des matériaux céramiques convergent à la perfection, en leur conférant un effet sensoriel ultraréaliste.

Con la tecnología de impresión digital de última generación TECH 3D, Revigrés introduce superficies innovadoras, en las que los gráficos y las texturas de los materiales cerámicos convergen a la perfección, aportandoles un efecto sensorial ultrarrealista.



TRAVERTINO CLASSIC OFFWHITE

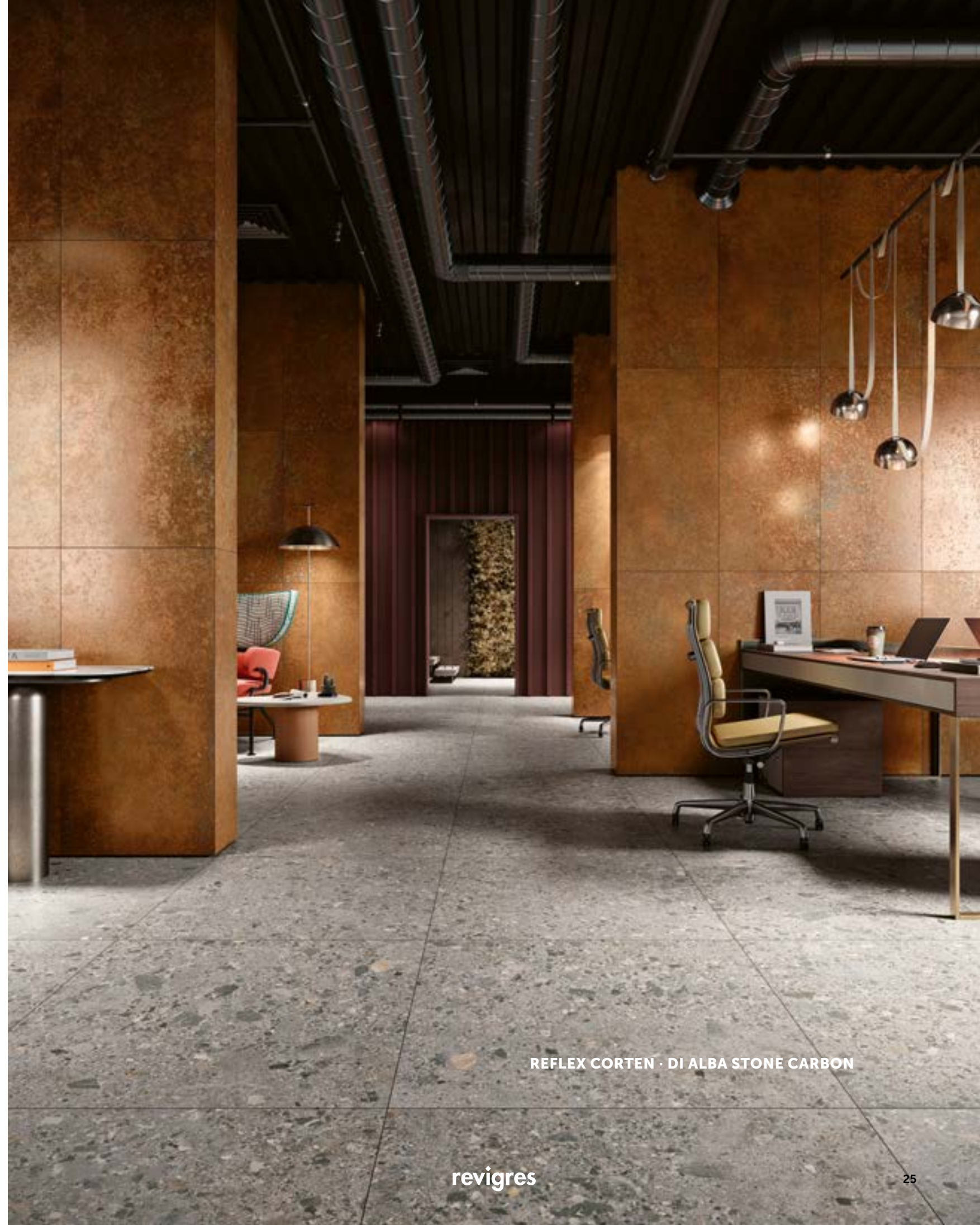

REFLEX CORTEN · DI ALBA STONE CARBON



REFLEX OXIDE · REFLEX CARBON · LIMESTONE MIST

REFLEX

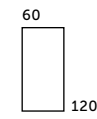

REFLEX CARBON
59,2x118,6 cm
RECT ± 0,98 cm **P114**



REFLEX CORTEN
59,2x118,6 cm
RECT ± 0,98 cm **P114**

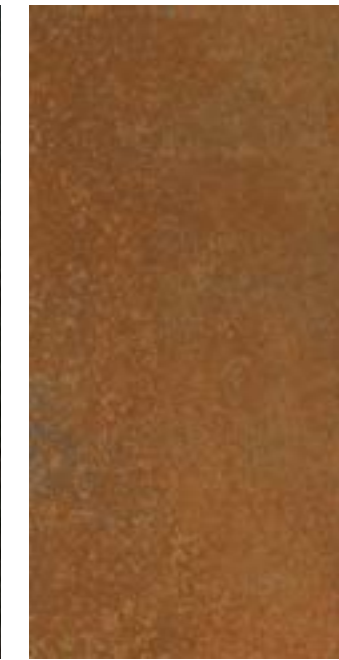

REFLEX OXIDE
59,2x118,6 cm
RECT ± 0,98 cm **P114**

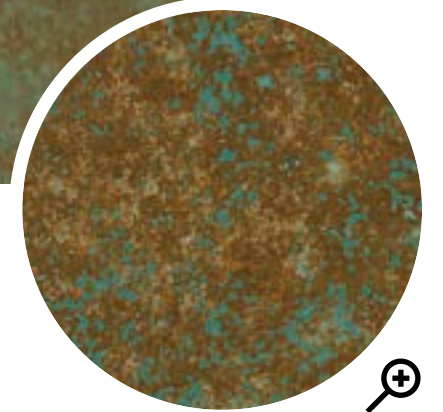

REFLEX SILVER
59,2x118,6 cm
RECT ± 0,98 cm **P114**

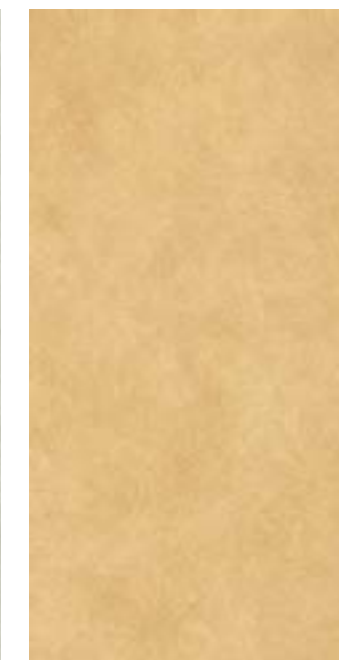

REFLEX GOLD
59,2x118,6 cm
RECT ± 0,98 cm **P114**

UP TO 16 DESIGNS
ATÉ 16 DESENHOS
JUSQU'À 16 DESSINS
HASTA 16 DISEÑOS

Tendo em vista alcançar um efeito global mais real e harmonioso, são produzidas peças diferentes umas das outras com variações de desenho e/ou cores entre elas.

For a more genuine and harmonious effect overall, different tiles with design and/or colour variations are produced.

Afin d'obtenir un effet global plus réel et harmonieux, nos pièces sont différentes les unes des autres avec des variations de dessin et/ou de nuances entre elles.

Para lograr un efecto global más real y armonioso, se producen piezas diferentes unas de otras con variaciones de diseño y/o color.

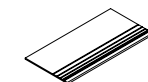

DG
29,5x59,2 cm **P18**
59,2x118,6 cm **P167**



RB
8x59,2 cm **P12**
8x118,6 cm **P28**

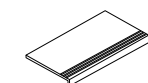

DG CF
29,5x59,2 cm **P157**

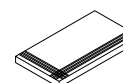

DG CF CANTO
29,5x59,2 cm **P207**

BLOCK-BRICK MATTE

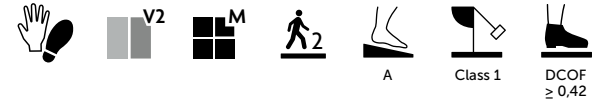

BLOCK MATTE

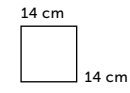

UP TO 40 DESIGNS
ATÉ 40 DESENHOS
JUSQU'À 40 DESSINS
HASTA 40 DISEÑOS



BLOCK WHITE MATTE
14x14 cm ± 0,85 cm P97



BLOCK CRAFT MATTE
14x14 cm ± 0,85 cm P97



BLOCK GREEN MATE
14x14 cm ± 0,85 cm P97



BLOCK BLUE MATTE
14x14 cm ± 0,85 cm P97



BLOCK TERRACOTTA MATTE
14x14 cm ± 0,85 cm P97



BLOCK BLACK MATTE
14x14 cm ± 0,85 cm P97

BRICK MATTE

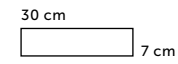

BRICK WHITE MATE
7x29 cm ± 0,85 cm P97

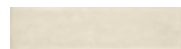

BRICK CRAFT MATE
7x29 cm ± 0,85 cm P97



BRICK GREEN MATE
7x29 cm ± 0,85 cm P97



BRICK BLUE MATE
7x29 cm ± 0,85 cm P97



BRICK TERRACOTTA MATE
7x29 cm ± 0,85 cm P97



BRICK BLACK MATE
7x29 cm ± 0,85 cm P97

Tendo em vista alcançar um efeito global mais real e harmonioso, são produzidas peças diferentes umas das outras com variações de desenho e/ou cores entre elas.
For a more genuine and harmonious effect overall, different tiles with design and/or colour variations are produced.
Afin d'obtenir un effet global plus réel et harmonieux, nos pièces sont différentes les unes des autres avec des variations de dessin et / ou de nuances entre elles.
Para lograr un efecto global más real y armonioso, se producen piezas diferentes unas de otras con variaciones de diseño y/o color.



UTOPIA



BRICK BLACK MATTE · BRICK GREEN MATTE · DI ALBA STONE GREY

BLOCK-BRICK GLOSSY

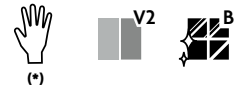

BLOCK GLOSSY

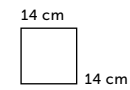

UP TO 40 DESIGNS
ATÉ 40 DESENHOS
JUSQU'À 40 DESSINS
HASTA 40 DISEÑOS



BLOCK WHITE GLOSSY
14x14 cm ± 0,85 cm P97



BLOCK CRAFT GLOSSY
14x14 cm ± 0,85 cm P97



BLOCK GREEN GLOSSY
14x14 cm ± 0,85 cm P97



BLOCK BLUE GLOSSY
14x14 cm ± 0,85 cm P97



BLOCK TERRACOTTA GLOSSY
14x14 cm ± 0,85 cm P97



BLOCK BLACK GLOSSY
14x14 cm ± 0,85 cm P97

BRICK GLOSSY

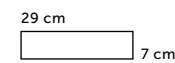

BRICK WHITE GLOSSY
7x29 cm ± 0,85 cm P97



BRICK CRAFT GLOSSY
7x29 cm ± 0,85 cm P97



BRICK GREEN GLOSSY
7x29 cm ± 0,85 cm P97



BRICK BLUE GLOSSY
7x29 cm ± 0,85 cm P97



BRICK TERRACOTTA GLOSSY
7x29 cm ± 0,85 cm P97



BRICK BLACK GLOSSY
7x29 cm ± 0,85 cm P97

(*) ADEQUADO PARA REVESTIMENTO INTERIOR E EXTERIOR.

(*) SUITABLE FOR INTERNAL AND EXTERNAL WALLS.

(*) CONVIENT AUX MURS INTÉRIEURS ET EXTÉRIEURS.

(*) ADECUADO PARA REVESTIMIENTO INTERIOR Y EXTERIOR.

Tendo em vista alcançar um efeito global mais real e harmonioso, são produzidas peças diferentes umas das outras com variações de desenho e/ou cores entre elas.
For a more genuine and harmonious effect overall, different tiles with design and/or colour variations are produced.

Afin d'obtenir un effet global plus réel et harmonieux, nos pièces sont différentes les unes des autres avec des variations de dessin et / ou de nuances entre elles.

Para lograr un efecto global más real y armonioso, se producen piezas diferentes unas de otras con variaciones de diseño y/o color.



UTOPIA



BLOCK CRAFT GLOSSY · BLOCK BLACK GLOSSY · LOCUS GRIS · QUILT BONE

revigres

USEFUL INFORMATION

INFORMAÇÕES ÚTEIS · INFORMATIONS UTILES · INFORMACIÓN ÚTIL

TECHNICAL CHARACTERISTICS · CARACTERÍSTICAS TÉCNICAS · CARACTERISTIQUES TECHNIQUES · CARACTERÍSTICAS TÉCNICAS

MÉTODOS DE ENSAIO TEST METHODS	NORMA / STANDARD	GRÉS PORCELÂNICO TÉCNICO FULL BODY PORCELAIN TILES GRUPO · GROUP BIA UGL (EN 14411) (C)	
		VALORES MÉDIOS / AVERAGE VALUES	
		MATT RECT / RECT	POL
Comprimento e largura Length and width	± 0.9 mm [N < 15 cm] (*) ± 0.6% máx ± 2 mm [N ≥ 15 cm] (*)	± 0,1% máx. ± 1.0 mm	± 0,1% máx. ± 1.0 mm
Desvio da espessura média para a espessura de fabrico Deviation of mean thickness from manufacturing thickness	± 0.5 mm [7 cm ≤ N < 15 cm] (*) ± 5% máx ± 0.5 mm [N ≥ 15 cm] (*)	± 5% máx. ± 0.5 mm	± 5% máx. ± 0.5 mm
Retililinearidade das arestas Straightness of the edges	± 0.75 mm [7 cm ≤ N < 15 cm] (*) ± 0.5% máx ± 2.0 mm [N ≥ 15 cm] (*)	± 0,2% máx. ± 1.0 mm	± 0,2% máx. ± 1.0 mm
Ortogonalidade Orthogonality	± 0.75 mm [7 cm ≤ N < 15 cm] (*) ± 0.5% máx ± 2.0 mm [N ≥ 15 cm] (*)	± 0,2% máx. ± 1.5 mm	± 0,2% máx. ± 1.5 mm
Planaridade da superfície Surface flatness	± 0.75 mm [7 cm ≤ N < 15 cm] (*) ± 0.5% máx ± 2.0 mm [N ≥ 15 cm] (*)	± 0,3% máx. ± 1.8 mm	± 0,2% máx. ± 1.8 mm
Qualidade da superfície (% isenta de defeitos) Surface quality (% defect-free)	≥ 95%	Cumpre Compliant	Cumpre Compliant
Absorção de água Water absorption	< 0,5%	< 0,05%	< 0,05%
Módulo de Ruptura (N/mm²) Rupture modulus (N/mm²)	> 35	> 45	> 45
Resistência à Flexão (N): Bending Strength (N):			
7,0 mm < Espessura < 8,5 mm 7,0 mm < Thickness < 8,5 mm	≥ 1300	> 2000	> 2000
8,5 mm < Espessura < 14 mm 8,5 mm < Thickness < 14 mm	≥ 1300	> 3500	> 3500
14 mm ≥ Espessura 14 mm ≥ Thickness	≥ 1300	> 6500	> 6500
= 20 mm Espessura = 20 mm Thickness	≥ 1300	> 13500	> 13500
Resistência à abrasão profunda (Volume removido/mm³) Resistance to deep abrasion (Removed volume/mm³)	< 175	< 120	< 120
Coefficiente de Dilatação Térmica Linear (da temperatura ambiente até 100 °C) Coefficient of Linear Thermal Expansion (with atmospheric temperature up to 100 °C)	Método de ensaio disponível Test method available	≤ 8,0x10 ⁻⁶ / °C	≤ 8,0x10 ⁻⁶ / °C
Resistência ao choque térmico Resistance to thermal shock	Exigida Required	Resiste Resistant	Resiste Resistant
Resistência ao gelo Resistance to frost	Exigida Required	Sem defeitos visíveis Without visible defects	Sem defeitos visíveis Without visible defects
Resistência a Ácidos e Bases de Alta Concentração Resistance to Acids and High Concentration Bases	O produtor declara a classificação The producer declares the classification	Classe HA Type HA	Ensaio disponível Test available
Resistência a Ácidos e Bases de Baixa Concentração Resistance to low concentrations of acids and alkalis		Classe LA Type LA	Mín. Classe LB Min. Type LB
Resistência a Produtos Químicos Domésticos e Aditivos para Água de Piscinas Resistance to Household Chemicals and Swimming pool water additives	Mín. Classe B Min. Type B	Classe A Type A	Ensaio disponível Test available
Resistência a manchas Resistance to staining	Método de ensaio disponível Test method available	Classe 5 Type 5	Mín. Classe 3 Min. Type 3
DIN 51130	Máx R13 Max R13	Ensaio disponível Test available	-
DIN 51097	Máx C Max C	Ensaio disponível Test available	-
ENV 12633	Máx classe 3 Max type 3	Ensaio disponível Test available	-
BS 7976	Método de ensaio disponível Test method available	Ensaio disponível Test available	-
ANSI A137.1	Método de ensaio disponível Test method available	Ensaio disponível Test available	-
UPEC CSTB	Resistência ao choque pesado Resistance to heavy shock	Nível 0 a 5 Nível 0 to 5	-
EN 13823 EN 9239-1	Reacção ao fogo Reaction to fire	Classe A1_{fl} / Classe A1 Type A1 _{fl} / Type A1	Classe A1_{fl} / Classe A1 Type A1 _{fl} / Type A1

NOTES · NOTAS

- (a) **Exceto ao ácido fluorídico.**
Except hydrofluoric acid.
- (b) **Excepto Iron e Copper: Classe B e HB.**
Excluding Iron and Copper: Type B and HB.
- (c) **Os produtos podem ser aplicados em piso radiante.**
The products can be used with underfloor heating.
- (d) **DCOF ≥ 0.42 espaços interiores expectável de serem utilizados húmidos.**
DCOF ≥ 0.42 interior spaces expected to be used wet.

(*) N - Formato Nominal
(*) N - Nominal Size

- 1 Para os produtos com relevo, dado serem superfícies não planas, não são considerados os valores de curvatura e de empeno.
- 2 As especificações técnicas são válidas unicamente para os produtos classificados de 1ª escolha. O incumprimento dos valores indicados em outras classificações comerciais não será motivo de reclamação.
- 3 Valores típicos que correspondem a valores de referência de inspeção e ensaio.
- 4 Estão indicados os valores considerados mais relevantes das Características Técnicas dos vários produtos. No entanto, no caso de ser necessária alguma informação adicional, solicitamos o contato para: revigres@revigres.pt
- 1 In products with structured surfaces, curving and bending values are not considered.
- 2 Technical specifications are only valid for the products classified as 1st choice. The non-performance of the indicated values for other commercial classifications will not be considered as grounds for complaint.
- 3 Typical values corresponding to inspection and testing reference values.
- 4 The values considered to be most significant in terms of the Technical Properties of all products are specified. For more information please contact us at: revigres@revigres.pt

TIPOLOGIAS DE PRODUTOS · TYPES OF PRODUCTS · TYPOLOGIES DE PRODUITS · TIPOLOGÍAS DE PRODUCTOS



REVESTIMENTOS E PAVIMENTOS EM GRÉS PORCELÂNICO TÉCNICO
FULL BODY PORCELAIN WALL/FLOOR TILES
REVÊTEMENTS MURAUX ET DE SOL EN GRÉS CÉRAMÉ PLEINE MASSE
REVESTIMIENTOS Y PAVIMENTOS EN GRÉS PORCELÁNICO TÉCNICO



REVESTIMENTOS E PAVIMENTOS EM GRÉS PORCELÂNICO ESMALTADO
GLAZED PORCELAIN WALL/FLOOR TILES
REVÊTEMENTS MURAUX ET DE SOL EN GRÉS CÉRAMÉ EMAILÉ
REVESTIMIENTOS Y PAVIMENTOS EN GRÉS PORCELÁNICO ESMALTADO

ACABAMENTO DA SUPERFÍCIE · SURFACE FINISH · FINITION DE LA SUPERFICIE · ACABADO DE LA SUPERFICIE



MATE: superfície natural, não brilhante.
MATTE: natural surface, not shiny.
MAT: superficie naturelle, non brillante.
MATE: superficie natural, no brillante.



BRILHO: superfície brilhante, com alto grau de reflexão de luz.
GLOSS: shiny surface, with high degree of light reflection.
BRILLANT: surface brillant, avec haut niveau de reflet de la lumière.
BRILLO: superficie brillante, con alto grado de reflexión de la luz.

VARIAÇÕES DE TONALIDADE · COLOUR VARIATIONS · VARIATIONS DE TONALITÉ · VARIACIONES DE TONALIDAD



VARIACÃO MÉDIA: produto com evidente variação cromática.
MEDIUM VARIATION: product with visible colour variation.
VARIATION MOYENNE: produit présentant une variation de couleur évidente.
VARIACIÓN MEDIA: producto con evidente variación cromática.



VARIACÃO FORTE: produto com forte variação cromática.
HIGH VARIATION: product with strong colour variation.
VARIATION FORTE: produit présentant une forte variation de couleur.
VARIACIÓN FUERTE: producto con fuerte variación cromática.



VARIACÃO MUITO FORTE: produto com intensa variação cromática.
VERY WIDE RANGE: product with intense colour variation.
VARIATION TRÈS FORTE: produit présentant une intense variation de couleur.
VARIACIÓN MUY FUERTE: producto con intensa variación cromática.

TIPOS DE APLICAÇÃO · TYPES OF USE · TYPES D'APPLICATION · TIPOS DE APLICACIÓN



TRÁFEGO MÉDIO
MEDIUM TRAFFIC
TRAFIC MOYEN
TRÁFICO MÉDIO



TRÁFEGO MÉDIO-FORTE
MEDIUM HEAVY TRAFFIC
TRAFIC MOYEN-ÉLEVÉ
TRÁFICO MÉDIO FUERTE



TRÁFEGO FORTE
HEAVY TRAFFIC
TRAFIC ÉLEVÉ
TRÁFICO FUERTE



TRÁFEGO MUITO FORTE
VERY HEAVY TRAFFIC
TRAFIC TRÈS ÉLEVÉ
TRÁFICO MUY FUERTE

EMBALAGENS E PESOS · PACKING LIST AND WEIGHTS · EMBALAGES ET POIDS · EMBALAJES Y PESOS

PEÇAS · PIECES	CAIXA · BOX			EUROPALETE · EUROPALLET				
	Espeçura (mm) Thickness (mm)	Nº Peças No Pieces	M² Aprox. No of Sq. M. Approx.	Peso (Kg) Weight Kg	Nº Caixas No Boxes	M² Aprox. No of Sq. M. Approx.	Peso (Kg) Weight (Kg)	
LIGHT XL CALACATTA CLASSIC · LIMESTONE · RULE · STATUARIO WHITE								
119,8x277,8 cm (47"x109")	MATT RECT / RECT / POL	± 6,0 ±5%	1	3.33	50.4	18	59.94	1019
CALACATTA CLASSIC · CITYZEN · LIMESTONE · STATUARIO WHITE								
119,8x119,8 cm (47"x47")	MATT RECT / RECT POL / ANTISLIP RECT	± 9,0 ±5%	1	1.44	28.10	32	46.08	959.2
REFLEX · TRAVERTINO CLASSIC								
59,2x118,6 cm	RECT / MATTE RECT	± 9,8 ±5%	2	1.40	32.20	30	42.0	987
88,9x88,9 cm	RECT / MATTE RECT	± 10,5 ±0,5 mm	2	1.58	39.0	24	37.92	956
BLOCK								
14x14 cm		± 8,5 ±5%	25	0.52	9.83	40	20.8	414.12
BRICK								
7x29 cm		± 8,5 ±5%	40	0.85	16.07	30	25.2	502.95
TECH_{20mm} ANTISLIP URBAN · LAVASTONE								
59,8x119,6 cm (24"x47")	LAVASTONE ANTISLIP RECT	± 20,0 ±0,5 mm	1	0.72	35.20	36	25.92	1297.2
59,8x59,8 cm (24"x24")	ANTISLIP URBAN RECT	± 20,0 ±0,5 mm	2	0.72	35.20	32	23.04	1156.4

ÁGUEDA

Apartado 1
3754-001 Barrô AGD Portugal
Tel. +351 234 660 100 ^(a)
GPS 40.532865 N, 8.449056 W
(Gândara do Vale do Grou)

LISBOA

Pç. José Fontana 26 A-C
1050-129 Lisboa Portugal
Tel. +351 213 170 280 ^(a)
GPS 38.730144 N, 9.144978 W

SHOWROOMS

2ª a 6ª feira: 9.00-19.30h (Águeda:19.00);
Sábado: 9.30-13.30h
Monday to Friday: 9.00am-7.30pm (Águeda:7.00pm);
Saturday: 9.30am-1.30pm

^(a) custos de chamada para rede fixa nacional

revigres@revigres.pt
www.revigres.com



revigres